

83 lb/hr (870 cc/min) Pro Import Injector

05850PI

83lb/hr (870 cc/min) low impedance injector. Fits many Japanese/import applications.

Technical Specifications			
Flow Rate, lb/hr	83		
Flow Rate, cc/min	870		
Impedance	Low (NOTE: May not work with factory ECU).		
Connector Style	Rectangular (minitimer)		
Dimensions*			
A (upper o-ring)	0.430 inch	11 mm	
B (o-ring to o-ring length)	2.5 inch	63.5 mm	
C (lower o-ring)	0.630 inch	16 mm	
Recommended accessories	Component	P/N	
	Connector w/ wires:	0810	
	Connector only:	0811	

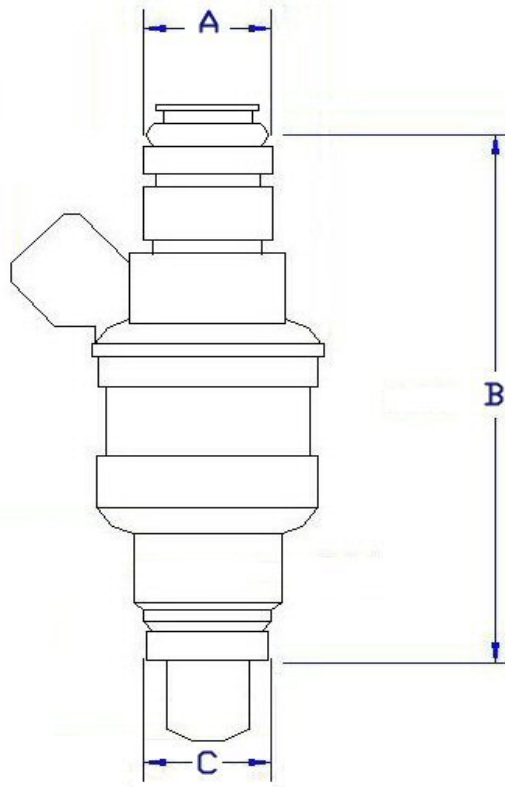

*Dimensions given are nominal and may vary slightly. For reference purposes only.

marren fuel injection

91 Willenbrock Road, Unit B2
Oxford, CT 06478
203-267-FUEL (3835)
www.injector.com

marren